

**pewag**

snow chains



**Schnellmontage ohne Spannkette / Quick assembly without tensioning chain / Montaggio rapido senza catena di tensionamento / Snelle montage zonder spankette / Montage rapide sans chaîne de tension / Rychlá montáž bez napínacího řetězu / Rýchla montáž bez napínania reťaze / Szybki montaż bez łańcucha napinającego / Hurtig montering uden at spænde kæden / Rask montering uten strammekjede / Snabb montering utan spännkedja / Pika-asennus ilman kiristyskettinkiä / Kiire kokkupanek ilma keti**

1

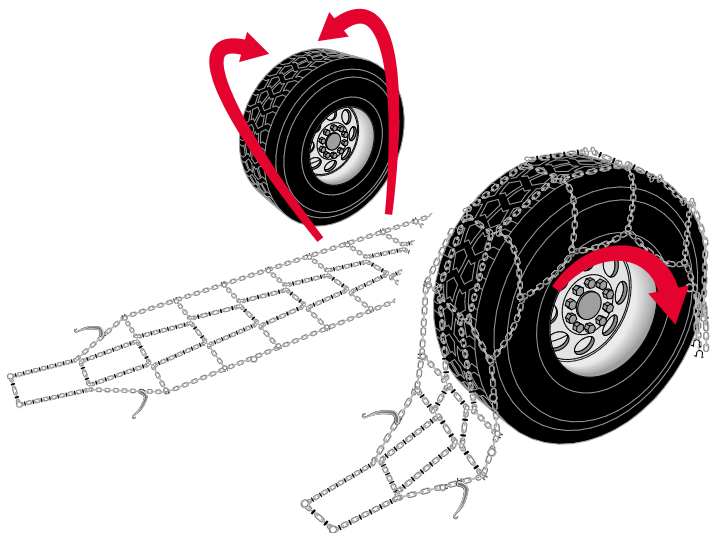

pinguldamiseta / Ātra montāža bez ķēdes nospriegošanas / Greitas surinkimas be ģtempimo grandinēs / Asamblare rapidă fără lanț de tensionare / Бърз монтаж без опъване на веригата / Γρήγορη συναρμολόγηση χωρίς αλυσίδα τάνυσης / Gyors összeszerelés láncfeszítés nélkül / Brza montaža bez zateznog lanca / Hitra montaža brez napenjalne verige / Montaje rápido sin cadena tensora / Montagem rápida sem corrente de tensão

2

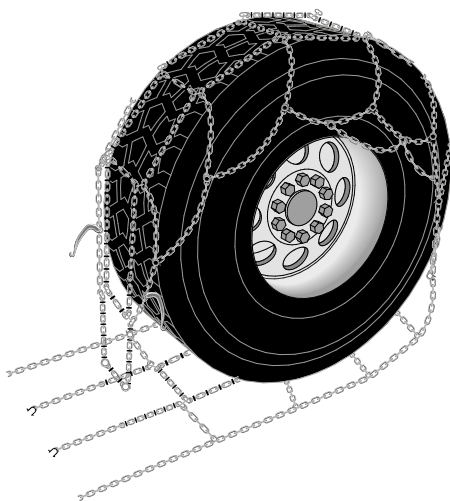

**Schnellmontage mit Spannkette / Quick assembly with tensioning chain / Montaggio rapido con catena di tensionamento / Snelle montage met spanketting / Montage rapide avec chaîne de tension / Rychlá montáž s napínacím řetězem / Rýchla montáž s napínacou reťazou / Szybki montaż z łańcuchem napinającym / Hurtig montering med spændekæde / Rask montering med spennkjede / Snabb montering med spännkedja / Pika-asennus**

1

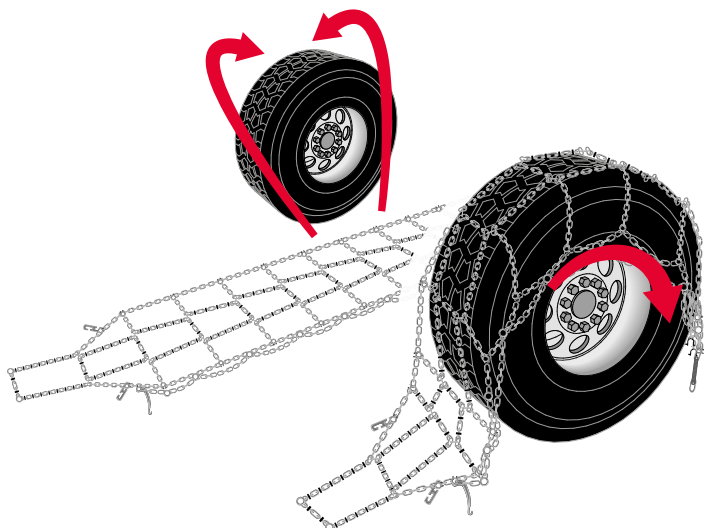

**kiristyskettingillä / Kiire kokkupanek koos pingutusahelaga /  
Ātra montāža ar spriegošanas ķēdi / Greitas surinkimas  
su įtempimo grandine / Asamblare rapidă cu lanț de  
tensionare / Бърз монтаж с опъваща верига / Γρήγορη  
συναρμολόγηση με αλυσίδα τάνυσης / Gyors összeszerelés  
feszítőlánccal / Brza montaża s zatezнім lancem / Hitra  
montāža z napenjalno verigo / Montaje rápido con  
cadena tensora / Montagem rápida com corrente tensora**

2

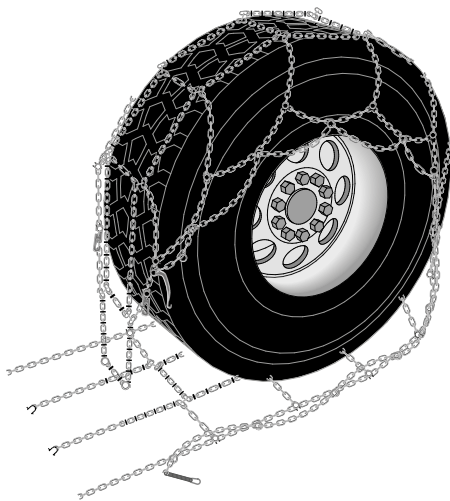

Montage ohne Spannkette / Mounting without tensioning chain / Montaggio senza catena di tensionamento / Montage zonder spanketting / Montage sans chaîne de tension / Montáž bez napínacího řetězu / Montáž bez napínaczej łańcucha napinającego / Montering uden spændekæde / Montering uten spennkjede / Montering utan spännkedja / Asennus ilman

1

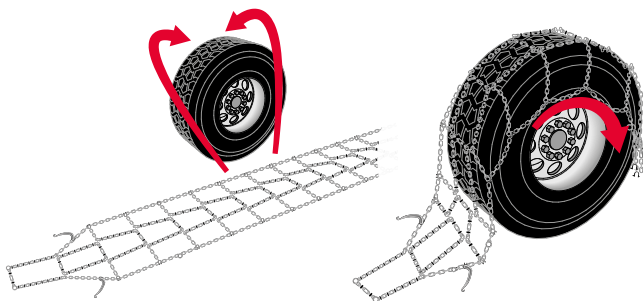

4

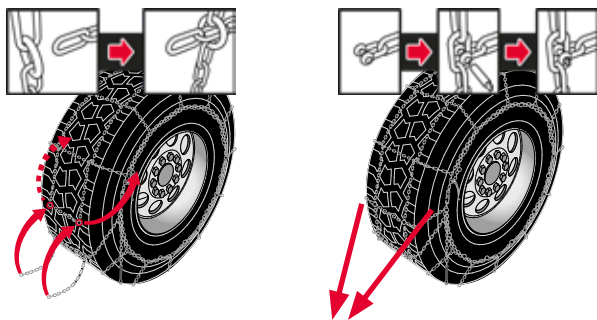

kiristyskettinkiä / Kokkupanek ilma pingutusahelata /  
Montaža bez spriegošanas ķēdes / Surinkimas be įtempimo  
grandinės / Ansamblu fără lanț de tensionare / Монтаж  
без опъваща верига / Συναρμολόγηση χωρίς αλυσίδα  
τάνυσης / Összeszerelés feszítő lánc nélkül / Ugradnja bez  
zateznog lanca / Montaža brez napenjalne verige / Montaje  
sin cadena tensora / Montagem sem corrente tensora

2

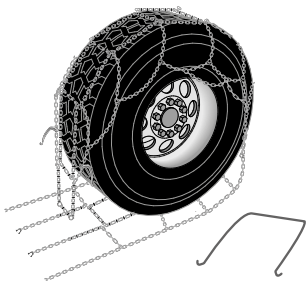

3

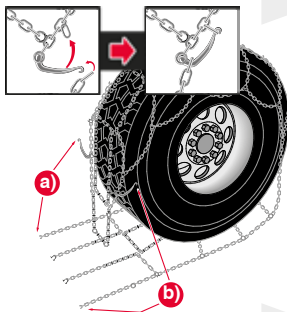

5



6



50 m

Montage mit Spannkette / Mounting with tensioning chain /  
Montaggio con catena di tensionamento / Montage met  
spanketting / Montage avec chaîne de serrage / Montáž  
s napínacím řetězem / Montáž s napínacou reťazou /  
Montaż z łańcuchem napinającym / Samling med  
spændekæde / Montering med strammekjede / Montering  
med spännkedja / Asennus kiristyskettingillä / Kokkupanek

1

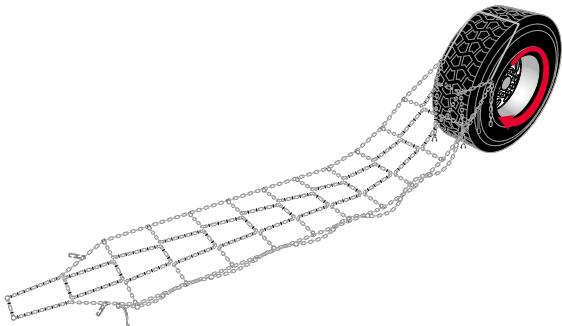

4

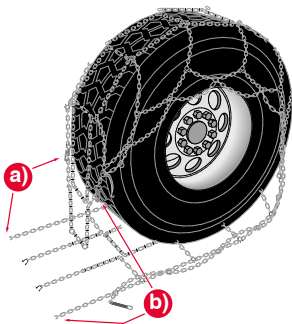



koos pingutusahelaga / Montāža ar spriegošanas ķēdi /  
Surinkimas su įtempimo grandine / Ansamblu cu lanț de  
tensionare / Монтаж с опъваща верига / Συναρμολόγηση  
με αλυσίδα τάνυσης / Összeszerelés m feszítő lánc / Montaža  
sa steznim lancem / Sestava z napenjalno verigo / Montaje  
con cadena tensora / Montagem com corrente tensora

2



3

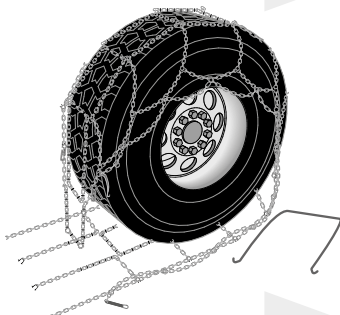

5

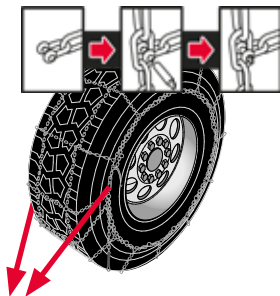
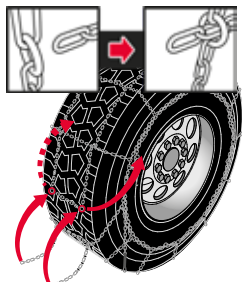

6

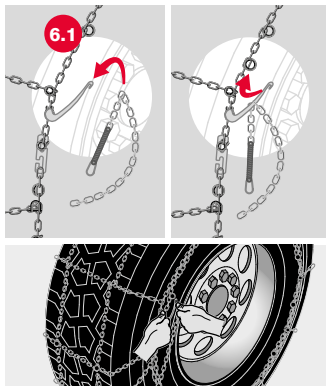

8

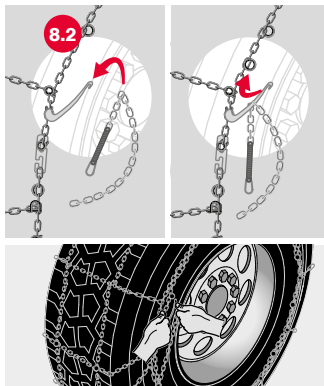

7



50 m

9



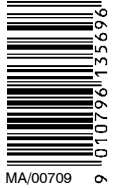

**pewag Schneeketten GmbH**

A-9371 Brückl, Kettenwerk 1

Phone: +43 50 50 11-0, Fax: +43 50 50 11-100

schneeketten@pewag.com, [www.pewag.com](http://www.pewag.com)

